

# OPERATING AND INSTALLATION MANUAL

## TANK-TYPE WATER HEATER FOR VERTICAL MOUNTING

**OKHE 100,125,160-SMART**



Družstevní závody Dražice-strojírna s.r.o.  
Dražice 69, 294 71 Benátky nad Jizerou  
tel.: +420 / 326 370 911  
e-mail: [export@dzd.cz](mailto:export@dzd.cz)

 **DRAŽICE**  
NIBE GROUP MEMBER

# CONTENTS

1	TECHNICAL SPECIFICATION OF PRODUCT .....	5
1.1	FUNCTION DESCRIPTION .....	5
1.2	ADVICE FOR CUSTOMERS .....	6
1.2.1	HOT WATER CONSUMPTION .....	6
1.2.2	ENERGY SAVING .....	6
1.2.3	EMERGENCY POWER CONSUMPTION .....	6
1.3	DESIGN AND GENERAL HEATER DIMENSIONS.....	8
1.3.1	DESCRIPTION OF BASIC PARTS OF THE HEATER .....	8
1.3.2	HEATER DIMENSIONS .....	9
2	OPERATION AND FITTING INSTRUCTIONS.....	10
2.1	OPERATING CONDITIONS .....	10
2.2	WALL MOUNTING.....	10
2.3	PLUMBING FIXTURE.....	11
2.4	ELECTRIC WIRING .....	12
2.4.1	ELECTRIC INSTALLATION GENERAL INFORMATION.....	12
2.4.2	ELECTRONIC THERMOSTAT CONNECTION DIAGRAM .....	13
2.5	FIRST HEATER COMMISSIONING .....	14
2.6	PUTTING OUT OF SERVICE, DISCHARGE .....	14
2.7	INSPECTION, MAINTENANCE & CARE FOR THE APPLIANCE .....	15
3	OPERATION OF THERMOSTAT .....	16
3.1	OPERATING MODES AND THEIR SYMBOLS.....	16
3.1.1	SMART MODE .....	17
3.1.2	SMART HDO MODE.....	17
3.1.3	MANUAL MODE.....	17
3.1.4	MANUAL HDO MODE .....	17
3.1.5	OPTIMUM IN MODE MANUAL AND MANUAL HDO .....	18
3.1.6	PROG MODE .....	18
3.1.7	ANTI-FREEZE MODE .....	18
3.2	THERMOSTAT CONTROL.....	18
3.2.1	LED DISPLAY.....	18
3.3	FUNCTION DESCRIPTION .....	19
3.4	THE DISPLAY MODES ON THE DISPLAY.....	19
3.5	SETTING HDO (BULK REMOTE CONTROL) .....	20

3.6	CONTROLS DESCRIPTION .....	22
3.6.1	MODE CHANGE WITH CONTROLLER .....	22
3.6.2	BASIC DISPLAY .....	22
3.6.3	TEMPERATURE SETTING .....	22
3.6.4	TIME SETTING .....	22
3.6.5	FAILURE STATE.....	23
4	SOFTWARE FOR MOBILE DEVICES .....	24
4.1.1	BASIC DESIGN .....	24
4.1.2	PAIRING SCREEN .....	25
4.1.3	SIGNPOST ON FIRST STARTUP .....	25
4.1.4	MODE SECTION.....	27
4.1.5	PROGRAM SECTION .....	27
4.1.6	VACATION SECTION .....	29
4.1.7	STATISTICS SECTION .....	29
4.1.8	SECTION SETTINGS.....	30
4.1.9	INFO AND TIPS .....	32
4.1.10	SYNCHRONIZING TIME.....	32
4.1.11	SAVING THE COMPLETED SETTING.....	32
5	IMPORTANT NOTICES .....	32
5.1	INSTALLATION REGULATIONS.....	32
5.2	TRANSPORT & STORAGE INSTRUCTIONS .....	33
5.3	DISPOSAL OF PACKAGING MATERIAL AND NON-FUNCTIONING PRODUCT.....	33

## CAREFULLY READ THIS MANUAL BEFORE INSTALLING THE WATER HEATER!

Dear Customer,

Družstevní závody Dražice - strojírna s.r.o., would like to thank you for your decision to use a product of our brand. With this guide, we will introduce you to the use, construction, maintenance and other information on electrical water heaters.



The product is not intended to be controlled by

- a) people (including children) with reduced physical, sensual or mental capacities, or
- b) people with insufficient knowledge and experiences unless supervised by responsible person, or unless properly instructed by such responsible person.

The manufacturer reserves the right for engineering modification of the product. The product is designed for permanent contact with drinkable water.

It is recommended to use the product in indoor environment with air temperatures from +2 °C to +45 °C and a relative humidity up to 80 %.

Product's reliability and safety is proven by tests implemented by the Engineering Test Institute in Brno.

Made in the Czech Republic.

---

**This product contains an electrostatic sensitive component (electronic thermostat). During the mounting or maintenance of this product please follow general principles described in the EN/IEC 61340 series standard - Electrostatics and related standards.**

---

### Meaning of pictograms used in the Manual



**Important information for heater users.**



**Abiding by the recommendations of the manufacturer serves to ensure trouble-free operation and the long service life of the product.**



**Caution!**  
**Important notice to be observed.**

# 1 TECHNICAL SPECIFICATION OF PRODUCT

## 1.1 FUNCTION DESCRIPTION

The heater is designed for accumulation hot water using electricity. Water is heated by an electric element in an enameled thermally insulated tank. The unit is controlled by means of the control unit during heating period. Turning of the round controller to the left and to the right enables switching between one and four modes (see Table 1). The internal control unit includes intelligent thermostat SMART and receiver HDO (Bulk remote control). It differentiates high and low tariff according to the code setting (see chapter 3.5 setting the receiver HDO). Information on high and low tariff can be used in modes MANUAL and SMART. The user can select one of four operating modes specified in the table below.

	OPERATING MODES	BRIEF DESCRIPTION
1	SMART	Intelligent thermostat with reaction to the consumption of hot water
	SMART HDO	SMART mode with signal memory HDO
2	MANUAL	Common thermostat
	MANUAL HDO	Common thermostat blocked with signal HDO
3	PROG	Common thermostat with weekly program
4	ANTI-FREEZE	Boiler shut-down with minimum temperature monitoring 5 °C

Table 1



In modes SMART, SMART HDO, MANUAL a MANUAL HDO it is possible to control with signal HDO decoded with internal receiver. If the servicing interface is used (application for Android or iOS) for activating receiver HDO, then modes SMART and MANUAL are replaced with SMART HDO and MANUAL HDO.

Once the selected temperature is reached, heating interrupts automatically. Water accumulated in the tank is then used for consumption. The tank keeps constant pressure of water from the water main. If the combination faucet hot water valve is opened, water from the water supply conduit pressed out by cold water pressure flows out of the heater. Hot water flows out through the top part, and inflowing water remains in the bottom part of the heater.

## 1.2 ADVICE FOR CUSTOMERS

### 1.2.1 HOT WATER CONSUMPTION



Consumption of hot water in households depends on the number of people, amount of sanitary equipment, length, diameter and insulation of piping in the flat, or on individual habits of users. The cheapest option of water heating comes at the time when the electricity rate is reduced.



Find out in what time intervals your electricity supplier provides reduced tariff and, depending on that information, select relevant volume and power input of the heater so that your hot water consumption covered the needs of your household.

### 1.2.2 ENERGY SAVING



If you use electronic thermostat in the mode which enables manual setting of the required temperature, set it only for the value which you need for the household operation. Thus, you will reduce electricity consumption, as well as the amount of lime sediments on the walls of the receptacle and on the electric element's pit. Manufacturer recommended temperature for the lowest possible heat loss is 55 °C. **Higher saving of electricity requires one of the intelligent operating modes - SMART or PROG (more information on the operating modes is in chapter „3 thermostat operation“).**

### 1.2.3 EMERGENCY POWER CONSUMPTION



According to current legislation, the standby consumption is stated in the value of annual consumption of electric energy (kWh), which is measured according to the corresponding load profile and calculated according to the formulas and requirements of EU Regulation No. 812/2013.

TYP		OKHE 100 - SMART	OKHE 125 - SMART	OKHE 160 - SMART
VOLUME	l	100	125	149
MAX OPERATING OVERPRESSURE IN THE TANK	bar		6	
ELECTRICAL CONNECTION			1/N/PE ~ 230V/50 Hz	
RECOMMENDED BREAKER			16 A	
INPUT	W		2200	
EL. PROTECTION			IP44	
MAX TEMPERATURE TV	°C		80	
RECOMMENDED HOT WATER (HW) TEMPERATURE	°C		60	
MAX WEIGHT OF THE HEATER WITHOUT WATER	kg	39	46	52
TIME OF EL. HEATING FROM 10 °C TO 60 °C	hours	2.6	3.3	3.9
ELECTRICITY CONSUMPTION FOR HEATING THE VOLUME FROM 15°C TO 65°C	kWh	6	8	9.5
MIXED WATER V40	l	165.41	231.10	242.83
LOAD PROFILE		M	M	L
ENERGY EFFICIENCY CLASS		B	B	C
ENERGY EFFICIENCY	%	40	40	40
ANNUAL CONSUMPTION OF ELECTRIC ENERGY	kWh	1217	1255	2487

Table 2

## 1.3 DESIGN AND GENERAL HEATER DIMENSIONS

The heater tanks are made of a steel plate and tested by 1.5 multiple of operation pressure value. The inside of the tank is enameled. A flange is welded onto the bottom of the tank with a flange lid screwed to it. A sealing ring is inserted between the flange lid and the flange. Thermowells for placing a heating element and sensors of thermostat and safety fuse are located in the flange lid. The flange lid includes the automatically measured anode rod. The main electrical installation is placed in the plastic box assembled directly on the flange lid. Water temperature and other comfort functions can be set mechanically or by means of mobile device (more in chapters below).

### 1.3.1 DESCRIPTION OF BASIC PARTS OF THE HEATER

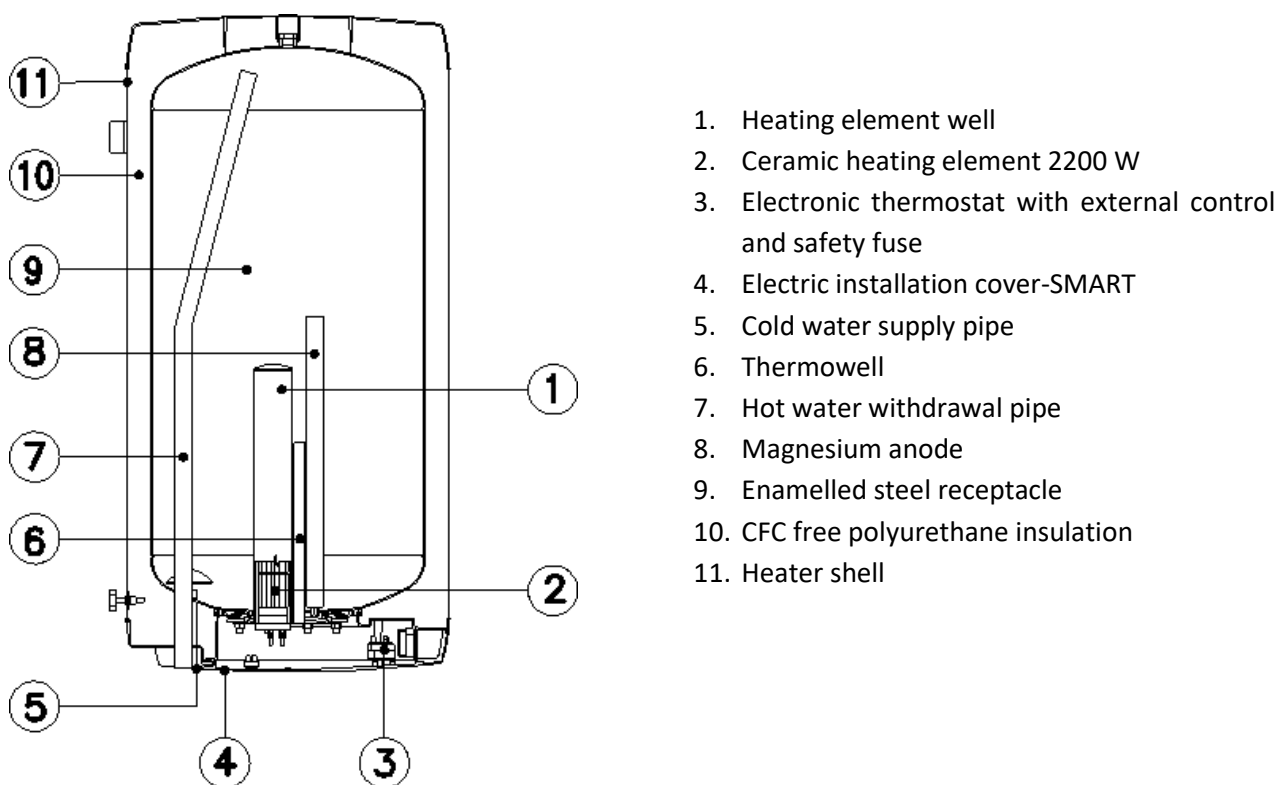

Figure 1



### 1.3.2 HEATER DIMENSIONS

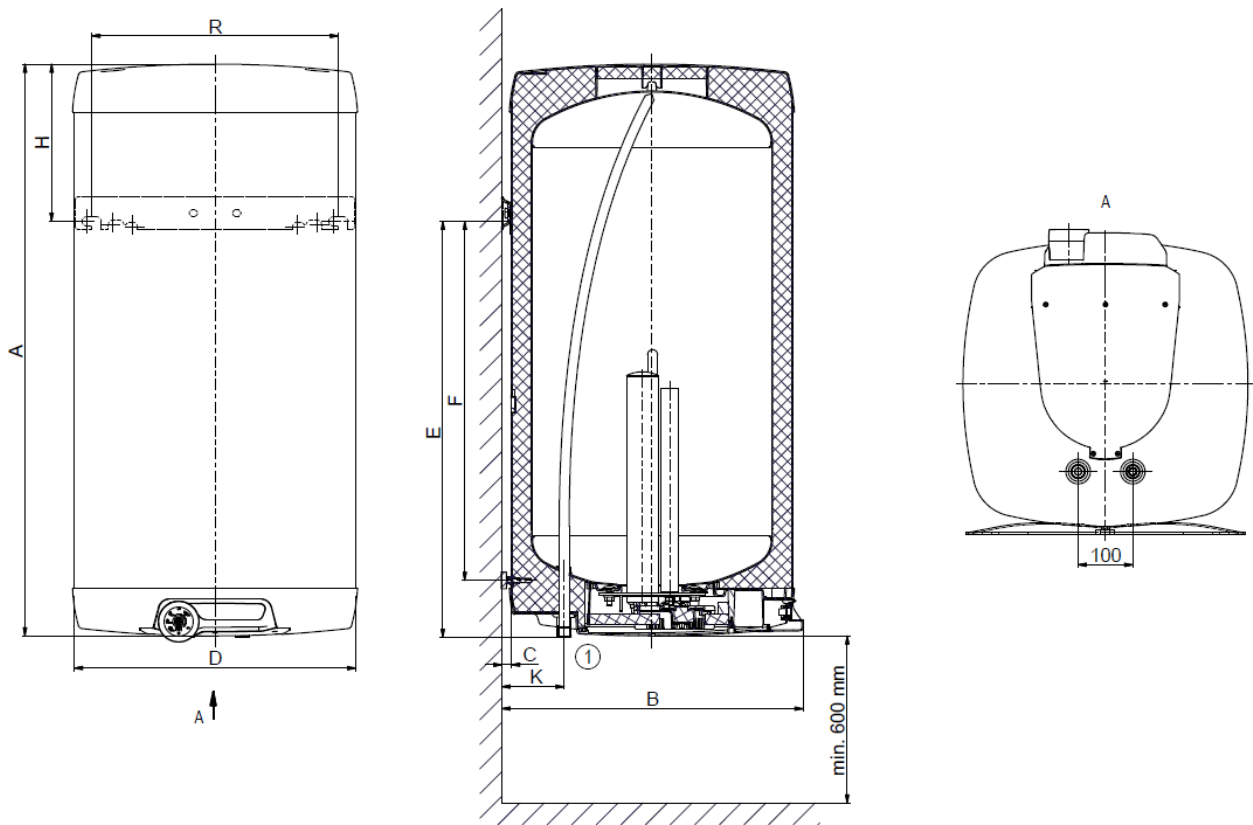

Figure 2

①

3/4" outer

	OKHE 100 - SMART	OKHE 125 - SMART	OKHE 160 - SMART
<b>A</b>	885	1050	1235
<b>B</b>	550	550	550
<b>C</b>	19	19	19
<b>D</b>	520	520	520
<b>E</b>	727	757	1000
<b>F</b>	605	638	880
<b>H</b>	148	283	225
<b>K</b>	117	117	117
<b>R</b>	450	450	450

Table 3

## 2 OPERATION AND FITTING INSTRUCTIONS

### 2.1 OPERATING CONDITIONS



The tank shall only be used in accordance with the conditions specified on the power plate and in instructions for electric wiring. Besides legally acknowledged national regulations and standards, also conditions for connection defined in local electric and water works have to be adhered to, as well as the installation and operation manual.

The temperature at the place of heater installation must be higher than +2 °C; and the room must not freeze. The appliance has to be mounted at a convenient place; it means that the appliance must be easily available for potential necessary maintenance, repair or replacement, as the case may be.



If water is strongly calcareous we recommend that any of the common decalcifying devices was installed with the appliance, or the thermostat to be set to minimum operation temperature of 55 °C (setting to position „OPTIMUM“) - Figure 6 . For proper operation, drinkable water of adequate quality shall be used. To avoid potential sediments, we recommend that the device was installed together with a water filter.

### 2.2 WALL MOUNTING



Prior to the mounting check the bearing capacity of the wall and the material it is made of, considering the weight of the heater filled with water. Depending on the wall material choose adequate fixtures. We recommend entrusting wall mounting and anchoring to a specialist company or discussing the anchorage with an expert. **When mounting the anchor bolts follow the guide provided by the anchor bolts' manufacturer.**

Mount the anchors by the dimensional drawing (Figure 2) in **450 mm** spacing. Double check the torque of the suspension bolts on the heater and suspend the heater. Using the detent support in the bottom part of the heater make sure it runs in parallel with the wall!



Figure 3



If the hot water heater is mounted in a **tight, small space**, or in an intermediate ceiling, etc., you have to make sure that the connecting side of the appliance (connections to water supply, area for electric plugging) remained accessible and no heat accumulation occurs. Free space of up to **600 mm** from the bottom edge of the heater has to be available under the heater. When mounted directly under the ceiling, the distance from the ceiling has to be **50 mm** at least.

If the water heater is mounted in enclosed areas, inter-ceilings, built-in structures and recesses, ensure sufficient access to service fittings, electrical terminal boards, anodes and manholes. Minimum spacing from manhole is 600 mm.

## 2.3 PLUMBING FIXTURE



The heater connects to water distribution tubes with G3/4" thread in the bottom part of the heater. Blue - cold water supply, red - hot water outlet. For potential disconnection of the heater, the service water inlets and outlets must be provided with screw coupling Js 3/4". The safety valve is mounted on the cold water inlet identified with a blue ring.



The heater must be equipped with a membrane, spring-loaded safety valve. Safety valves with fixed pressure settings from the manufacturer are used for the assembly. Each individually lockable heater must be fitted with a cap on the cold water inlet, a test valve or a stopper to check the operation of the check valve, with a check valve and a relief valve (Figure 4). **The safety valve with a check valve is supplied with the heater.**



It is necessary to check the safety valve each time before putting it into operation. It is checked by manual moving of the membrane from the seat, turning the make-and-break device button always in the direction of the arrow. After being turned, the button must click back into a notch. Proper function of the make-and-break device results in water draining through the safety valve outlet pipe. In common operation, such a check needs to be implemented at least once a month, and after each heater shutdown for more than 5 days. Water may be dripping off the drain pipe of the safety valve; the pipe must be open into the air, pointed down; environment temperatures must not drop below zero.

Required pressures - Table 4. We recommend that the hot water distribution from the heater was as short as possible to minimize heat losses.

START-UP PRESSURE OF THE SAFETY VALVE [MPa]	ALLOWABLE OPERATIONAL OVERPRESSURE OF THE WATER HEATER [MPa]	MAXIMUM PRESSURE IN THE COLD WATER PIPES [MPa]
0.6	0.6	up to 0.48

Table 4

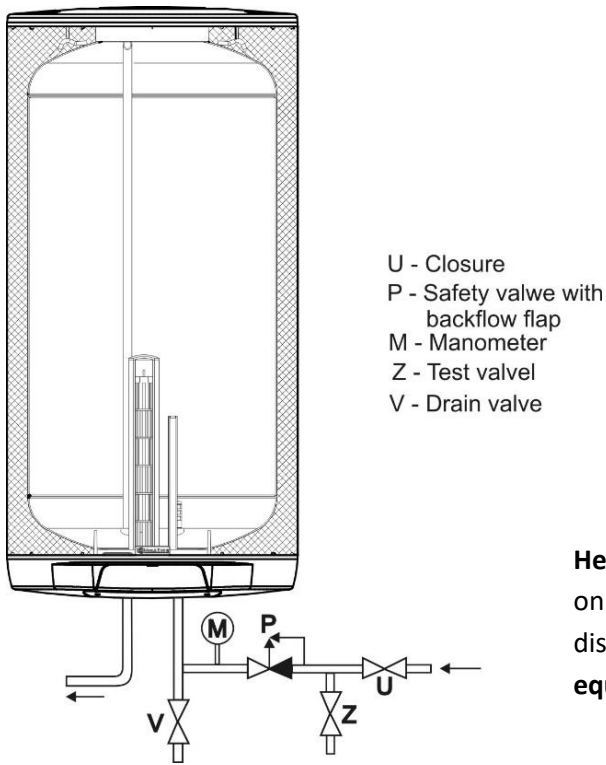

**Heaters must be provided with a discharge valve mounted on the cold service water inlet to the heater for potential disassembly or repair. When assembling the security equipment, follow the standard.**

Figure 4

## 2.4 ELECTRIC WIRING

### 2.4.1 ELECTRIC INSTALLATION GENERAL INFORMATION



**Do not plug the water heater in HDO socket; it would not work properly in SMART mode. The SMART mode (SMART HDO) will only work if 24/7 connected to power supply**

The degree of protection of electric parts of the heater is IP 44. Power input of electric element is 2200 W.

It is necessary to observe the below requirements during the electric wiring.



- Heater is connected to power supply 1 PEN AC 230V/50Hz via a fixed movable wire/wires (depending on the connection method) and must not be switched off according to the HDO signal.
- The circuit must contain a circuit breaker (protector).
- Installations in bathrooms, lavatories and showers must comply with the **ČSN 33 2000-7-701** standard.
- To adjust the distance from the wall, connect the wire of the external protective bonding!
- Respect the rules of protection against electrical injuries in accordance with **ČSN 33 2000-4-41**.



If the supply cord is damaged, it must be replaced by a company (person) authorized to such activity in order to avoid a hazard.

## 2.4.2 ELECTRONIC THERMOSTAT CONNECTION DIAGRAM

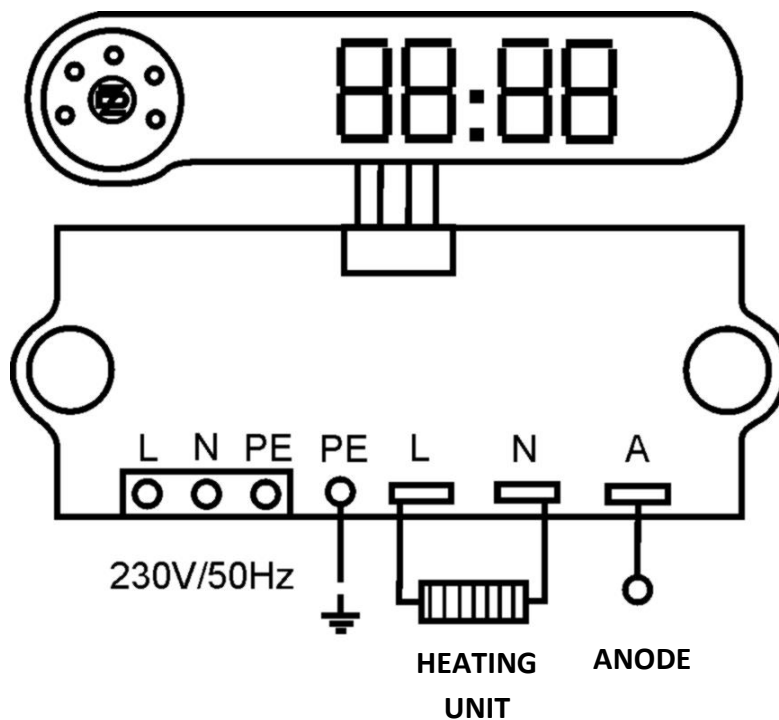

Figure 5

The terminals of L, N, PE (230V/50Hz) supply include factory connected flexible plug with length 2.5m connectable to the standardized plug EU. After the cover opening electrical wiring can be disconnected using flexible plug and connect the conductors into the cross-section up to 2.5 mm<sup>2</sup>.

## 2.5 FIRST HEATER COMMISSIONING



Before opening the power supply, the tank must be filled with water. The process of first heating must be executed by licensed professional who has to check it. Both the hot water outlet pipe and safety armature parts may be hot.



During the heating process the pressurized connection water that increases its volume due to heating must drip off the safety valve. In non-pressurized connection water drips off the overflow combination faucet. When heating is finished, the set temperature and the actual temperature of consumed water should be roughly equal. After connecting the heater to the water main and electrical power system, and after checking the safety valve (following the instructions attached to the valve), the heater can be put into operation.

### Procedure of putting the heater into operation:

1. Check the water main and wiring. Check proper placement of thermostat and safety fuse sensors. Electronic thermostat contains two temperature sensors placed on the holder that defines their exact position in the thermowell. The upper sensor is placed in a **360** mm distance, and the lower in a **180** mm from the bottom edge of the thermowell. The accurate position of the sensor is necessary to ensure proper function of the electronic thermostat and is defined by the sensor holder. Sensors has to be installed in to the sink as deep as possible - following the possibilities of each capillary, controlling thermostat has to be installed as first sensor in to the capillary, following by the safety thermostat as the second sensor installed in to the capillary.
2. Open the hot water valve on the combination faucet.
3. Open the cold water inlet valve to the heater.
4. As soon as the water starts running through the hot water valve, the heater is filled, and the valve can be closed.
5. In case of a leakage (flange lid), we recommend fastening the flange lid bolts. Screws has to be tightened by cross, tightening moment 15Nm.
6. Screw down the electric installation guard.
7. When hot service water heating by electric energy, switch on the power supply.
8. When commencing operation, flush the heater until the cloudiness in the water is gone.
9. Make sure to fill in properly the warranty certificate.
10. The control panel must be connected with the control unit for the correct heating function.

## 2.6 PUTTING OUT OF SERVICE, DISCHARGE



If the hot water heater is put out of service for a longer time, or if it is not going to be used it has to be drained and disconnected from the electric supply network. The switch for the supply lead or the fuse cut-outs have to be shut off.

At places with permanent risk of frost the hot water heater must be drained before the cold season starts if the appliance remains out of service for several days and if the power supply is disconnected. Alternatively, an antifreeze protection can be activated (refer to ANTI-FREEZE MODE).

In case the heater is drained and connected to network 230V 50Hz, the function ANTIFREEZE is functional. At low temperatures, heating can be connected and the heater damaged.



Drainage of service water shall be performed after closing the shut-off valve in the cold water supply piping (through the discharge valve for safety valve combination), and with simultaneous opening of all hot water valves of connected fittings. **Hot water may outflow during the drainage!** If there is a risk of frost it has to be considered that not only the water in the hot water heater and in the hot water piping may get frozen but also the water in the entire cold water supply piping. It is therefore advisable to drain all fittings and piping that carry water, up to the part where the house water meter is installed (connection of the house to water main) which is not jeopardized by frost. When the tank is to be used again, it has to be filled with water and one needs to make sure that the water flowing out at the **hot water valves did not contain any bubbles.**

## 2.7 INSPECTION, MAINTENANCE & CARE FOR THE APPLIANCE



During the heating process the water that increases its volume during the heating must drip off the safety valve outlet (in non-pressurized connection this water drips off the combination faucet valve). In full heating (about 75 °C) the volumetric water gain is approx. 3 % of the tank capacity. The function of the safety valve has to be checked regularly (based on the information contained in the attached safety valve manual). In common operation, such a check needs to be implemented at least once a month, and after each heater shutdown that exceeds 5 days.



**Attention!** In doing so, the cold water supply pipe and the connection fitting of the tank may get heated! If the hot water heater does not work, or if hot water is not withdrawn, no water shall drip off the safety valve. If water drips, then the pressure in the supply piping is either too high, or the safety valve is defective. Please call a specialized plumber immediately!



If water contains too many minerals, an expert has to come to remove the scale that forms inside the tank, as well as free sediments. This has to be performed after one or two years of operation. The cleaning is carried out through the hole in the flange by draining the boiler, dismantling the flange lid and cleaning the tank. A new sealing has to be used for re-fitting. Since the inside of the heater has special enamel, the surface of which must not get in contact with a scale removing agent - do not work with a lime pump. Remove the lime layer with a timber and suck it off or wipe it off with a clout. After that, the appliance must be rinsed thoroughly, and the heating process is checked the same as during the initial putting in operation. Do not use any abrasive cleaning agents or dye thinners to clean the outer shell of the heater (such as cellulose thinner, trichlor, and the like). For cleaning use a wet clout and add a few drops of liquid cleaning agent for household applications.

### 3 OPERATION OF THERMOSTAT

Electronic thermostat for controlling electrical water heaters of DZ Dražice allows multiple operating modes along with providing comfort functions. The thermostat contains a display and round controller that allows setting of the heater.

#### 3.1 OPERATING MODES AND THEIR SYMBOLS



Figure 6: Round controller



### 3.1.1 SMART MODE



In this mode the controller passes through two phases in order to save at least 10 % of electric power, comparing to the MANUAL mode. In the first phase in one calendar week the constant temperature of the heater 65 °C is maintained, and the control electronics monitors the user's behavior in terms of water consumption. This information is recorded and subsequently processed. In the second phase (which starts the following calendar week) the controller applies the information obtained in the first phase and prepares only such amount of water that user consumes in relevant time, leaving a certain reserve for case of unexpected water withdrawal. In this phase water consumption data are collected and evaluated. The obtained information is applied in such manner to adapt continuously to user's requirements. During this mode, minimum temperature is maintained automatically at **45 °C** and maximum temperature at 70 °C.

Learned data are recorded in the heater internal memory. After longer electrical network failure (several hours) the actual time of the heater is lost. The correct repeated function of mode SMART requires its manual update (chapter 3.6.4 - time setting), or by means of mobile application.

After switching from SMART mode to another mode, the data update on consumption is stopper, after return to SMART mode, the regulation continues according to former saved data (i.e. no data deleting occurs).

### 3.1.2 SMART HDO MODE



The thermostat monitors the signal HDO and saves its weekly history. SMART HDO mode operates identical to SMART with the extension; based on saved history of HDO it assumes the high tariff periods when heating is not possible. It starts automatically heating the boiler in advance in order to have available required amount of hot water for the user consumption as recorded in the history of SMART mode consumptions. During high tariff, the switching of the heating spiral is blocked.

### 3.1.3 MANUAL MODE



Common thermostat mode. The controller keeps the heater at constant, user defined temperature in the range between **40 to 80 °C**. A standard thermostat function - keep the heater constantly warmed up to the set temperature.

### 3.1.4 MANUAL HDO MODE



When low price electricity tariff is detected, the controller keeps the heater at constant, user defined temperature, identically to MANUAL mode. During high tariff, the control of the heating spiral is blocked.

### 3.1.5 OPTIMUM IN MODE MANUAL AND MANUAL HDO



Recommended temperature for manual setting (55 °C). During this temperature, the best efficiency of smart heater is achieved.

### 3.1.6 PROG MODE



The mode is similar to MANUAL mode providing two temperatures are set to which the thermostat reacts. The switching between the temperatures is provided based on the weekly programmer program. Time differentiation of the weekly programmer is 1 hour. The weekly programmer configuration is performed by means of the control application Android or iOS.

If power failure occurs resulting in the loss of real time data, PROG mode cannot operate according to the set program until the user resets the correct time. In this case the heater temperature is regulated to higher temperature set for the mode PROG.

### 3.1.7 ANTI-FREEZE MODE



The mode of putting the heater out of operation (holiday program). Makes sure that the temperature of water in the heater does not drop below 5 °C (electricity supply is necessary). This function is functional in all mode, including active HDO and high tariff.

This sign includes green light on with active HDO receiver.

## 3.2 THERMOSTAT CONTROL

The heater control is possible by means of round controller clockwise and anticlockwise or by means of the application control on the device with Android and iOS (more info in chapter software for mobile devices).

### 3.2.1 LED DISPLAY

The front side of the heater includes the four-digit seven segment LED display, additionally to the heater. The display example is below.



### 3.3 FUNCTION DESCRIPTION

In basic mode the panel displays water temperature and uses the light of individual symbols on the round controller to display the actual operating mode. In case of the device defect, the LED display reports the type of detected defect. The tables below display all functions which can be controlled by means of the control panel and set individual heater modes.





The controller central part includes the symbols below:

SYMBOL	COLOUR	BRIEF DESCRIPTION
<b>SMART</b>	white	SMART mode indication
<b>MANUAL</b>	white	MANUAL mode indication
<b>OPTIMUM</b>	green	ECO stop indication (MANUAL mode with set temperature 55 °C)
<b>PROG</b>	white	PROG mode indication
<b>HDO <sup>1)</sup></b>	green	The light is on at the time of low tariff if the mode is on HDO
<b>ANTI-FREEZE <sup>1)</sup></b>	red	Indication of active mode ANTI-FREEZE MODE
<b>DZ (center)</b>	red	Indication of active heating spiral (gradual change of the light intensity with period approx 2 s); permanent light in rest state

**Table 5: List of symbols**

<sup>1)</sup> LED ANTI-FREEZE and HDO highlight the same symbol „off“ with two different colours (red, green)

### 3.4 THE DISPLAY MODES ON THE DISPLAY

DISPLAY MODE	GRAPHIC FORM - EXAMPLE
Temperature display	53 °C 
Time setting	12:34 
Display of a day in week	Mo - Sun 1-7 
Error display	Errors Er01 - Er99 
Display of the code for pairing with the control application	0000 - 9999 

**Table 6: The display modes on LED display**

## 3.5 SETTING HDO (BULK REMOTE CONTROL)

**This function works only in the Czech and Slovak Republics.**

Smart heater includes HDO receiver (bulk remote control). Correct function requires setting the HDO parameters by means of mobile application in the setting section. The setting parameters HDO are detailed in Table 7. To find out the presetting (A, B, DP (P)) and the frequency, it is necessary to open the main home cabinet (place with electricity meter and receiver of HDO signal), with specified code for the consumption location, ideally in the form of the presetting (A, B, DP (P)) + frequency. For example **A1B2DP12 194Hz**.



**Receiver type indication HDO.**

**HDO code is defined on the label.**

On receiver HDO there are 1, 2 or 3 codes depending on the agreed distribution rate. The figure displays the receiver with 3 codes.

Low tariff validity times are on [www.eon.cz/nizkytarif](http://www.eon.cz/nizkytarif).

In order to find out the low tariff validity period for your codes, enter the first specified code HDO which is defined on the device.

If you are from south Moravia, HDO code comprises of the combination of letters A, B and P with numbers e.g. „A1B8P1“.

If you are from south Bohemia, HDO code comprises of the combination of three numbers e.g. „127“.

**Figure 7: One of the receiver HDO options**

Another option is that the HDO receiver includes a different code, e.g. **A85**. This code must be entered in the electricity distributor web pages, where after entering and subsequent conformation, the code is displayed in required form. i.e. specifically in **A85** and the supplier ČEZ, the code is displayed **A1B8DP5**. At the same time with the code, the web pages of electricity distributor also list the accurate times of your cheap and expensive product tariffs. The frequency is always at the HDO receiver. E.g. in figure 9 the frequency is 216.66Hz

Reference to the supplier: ČEZ - <http://www.cezdistribuce.cz/cs/technicky-dispecink/hromadne-dalkove-ovladani.html>



Figure 8: Designation A85

CONFIGURATION OF PARAMETERS	OPTION
Temperature display	Active / inactive
Preset A	1 - 4
Preset B	1 - 8
Preset DP (P)	1 - 16
Frequency for detection	183.33 Hz, 191 Hz, 194 Hz, 216.66 Hz, 283.33 Hz

Table 7: Configurable parameters HDO

## 3.6 CONTROLS DESCRIPTION

### 3.6.1 MODE CHANGE WITH CONTROLLER

Setting the thermostat mode is performed by turning the controller. In case of turning clockwise and anticlockwise, the functions are gradually switched: ANTI-FREEZE, SMART, PROG, MANUAL. Each controller step changes the function to the next or changes temperature during mode MANUAL by 1 °C.

### 3.6.2 BASIC DISPLAY

In all modes during common operation the display contains the actual water temperature in the boiler and actual time in 24-hour format - the values alternate after 5 s:



If time is not set, then in modes ANTI-FREEZE and PROG the display contains the symbol:



(in other modes in case time is not set, only temperature is displayed)

Turning the controller sets time, see chapter Time setting.

### 3.6.3 TEMPERATURE SETTING

After turning the controller within scope of MANUAL mode (temperature setting), the display indicates the flashing temperature value which complies with the actual controller setting. After five seconds, the former display returns.

### 3.6.4 TIME SETTING

In order to set the real time hours of the thermostat control unit, it is necessary to turn the controller into the position ANTI-FREEZE and wait 2 s. After further controller turning anticlockwise, the value of hours is displayed in 24 hour format (hour data flashes), and turning sets the value. After setting hours, wait for five seconds – the minute value flashes and turn the controller to change the value.



After completing the minute setting, after next five seconds, the day setting occurs:



The controller turning sets the day in week (Monday to Sunday), and after five seconds, the setting is saved. Now it is necessary to reset the controller to the position compliant with the required mode, and e.g. also temperature.

### 3.6.5 FAILURE STATE

In case of the defect detected by thermostat, the display shows the defect code:



The error codes required by the client are specified in the table below.

Failure code	Status description
<b>Er01</b>	Excessive wear of anode (anode voltage is lower than the limit)
<b>Er02</b>	Upper temperature sensor defect
<b>Er03</b>	Lower temperature sensor failure
<b>Er04</b>	Internal memory content failure
<b>Er05</b>	Defect of both temperature sensors (upper and lower)
<b>Er06</b>	External memory content failure
<b>Er07</b>	Bluetooth communication error
<b>Er08</b>	Too high internal temperature on the thermostat
<b>Er09</b>	Too high temperature in the water heater

**Table 8: Failure codes ErXX**

If Er02 or Er03 is detected, the heater is in emergency mode when it only heats to 55 °C, and the SMART and SMART HDO modes do not function.

Reporting any error (Err) will always display in mobile application; specifically, in the upper error bar, as well as in Figure 9: Error message Er in mobile application.



Figure 9: Error message Er in mobile application

## 4 SOFTWARE FOR MOBILE DEVICES

Basic function software is the thermostat configuration and the display of the actual state. The application is functional:

- For the mobile device with the operating system Android 4.3 and higher,
- For Apple iPhone, iPad device with the operating system iOS 7.0 and higher.

The application can be downloaded for free on <http://www.dzd.cz/smart/en.html>

### 4.1.1 BASIC DESIGN

The mobile application automatically adjusts the size and design of some user interface parts according to the display size and its turning (width, height).

In case of width display, the monitor shows the navigation and status information together with the content of the respective section. In case of height display, the navigation panel with the status information uses the full display surface and functions as the main signpost or the home screen. The button with the left arrow icon at the top is used in individual sections are used for the transfer back to the signpost



Status information include in particular the data on actual water temperature and the set boiler mode (see Figure 10: Navigation panel) or during vacation. It also displays the orientation information on actually available amount of hot water (after mixing to 40 °C) which is symbolized by the tank icon with changing water level and data in liters (the value is approximate, and it is calculated from the actual temperature sensor value of water in boiler).

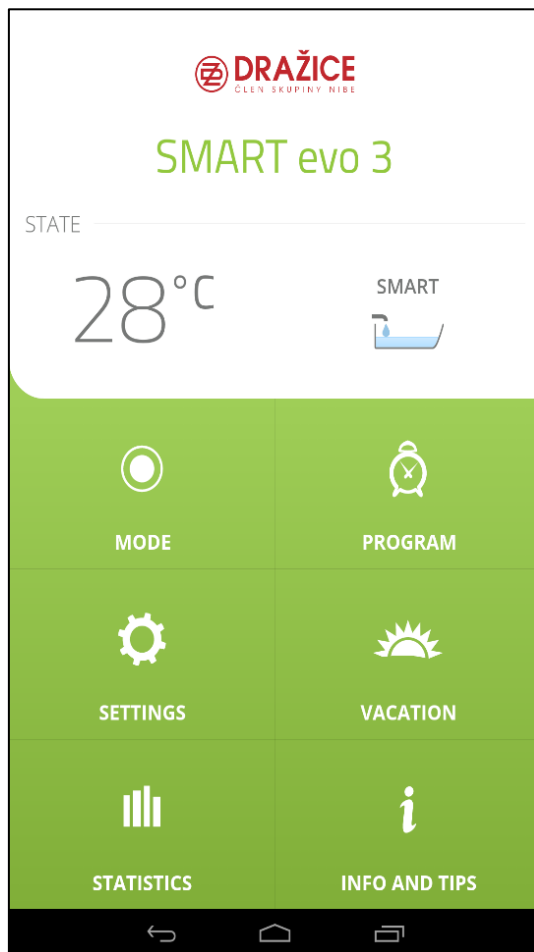

Figure 10: Navigation panel

#### 4.1.2 PAIRING SCREEN

After the first application start or the device disconnection, the list with available heaters is displayed so the user can simply select the heater to be controlled by means of the application. The selected heater pairs with the mobile application by means of PIN code which is on the LED display of the boiler control panel. When the mobile application is paired with the heater, the pairing does not need to be repeated until the user manually disconnects the connected device in the setting section (specified in chapter 4.1.8 Setting section).

#### 4.1.3 SIGNPOST ON FIRST STARTUP

When user connects for the first time, i.e. matches the mobile device to water heater, a simple signpost displays by which intelligent SMART functions or MANUL mode can be selected. Next submenu then offers an option of setting HDO with automatic detection, as advised in chapter 3.5 HDO SETTING, or an option of setting low tariff intervals. Combination of those options is not possible. The signpost can be returned to through the SETTING option. The signpost is displayed in the below figures.

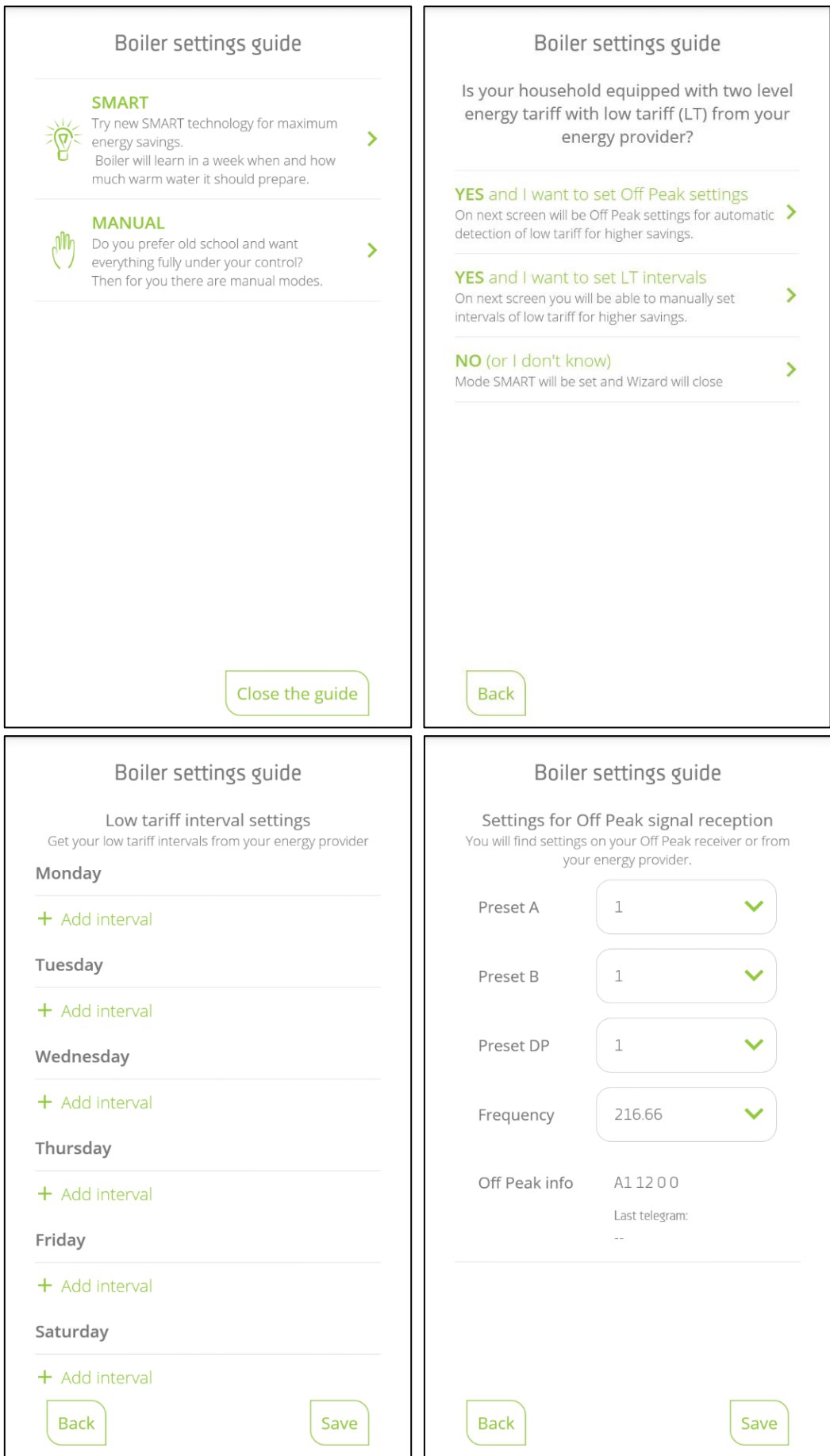

Figure 11: Signpost at first start

#### 4.1.4 MODE SECTION

After pairing the thermostat with the mobile device, the width display in section 'Mode' is set as the home screen, in case of height display it displays the signpost which can navigate to the section 'Mode'.

Identically to the real heater, turning the round controller enable setting the required mode (see Figure 12: Mode screen in width display). Turning the controller can be performed by finger turning on silver surface of the controller or by means of the buttons with the arrow symbols. Individual modes can be set directly by clicking on the icons symbolizing the respective modes. The upper right part displays the user set temperature. Water heating in progress is signaled by pulsing center of the displays controller in the application, identically to the real heater.

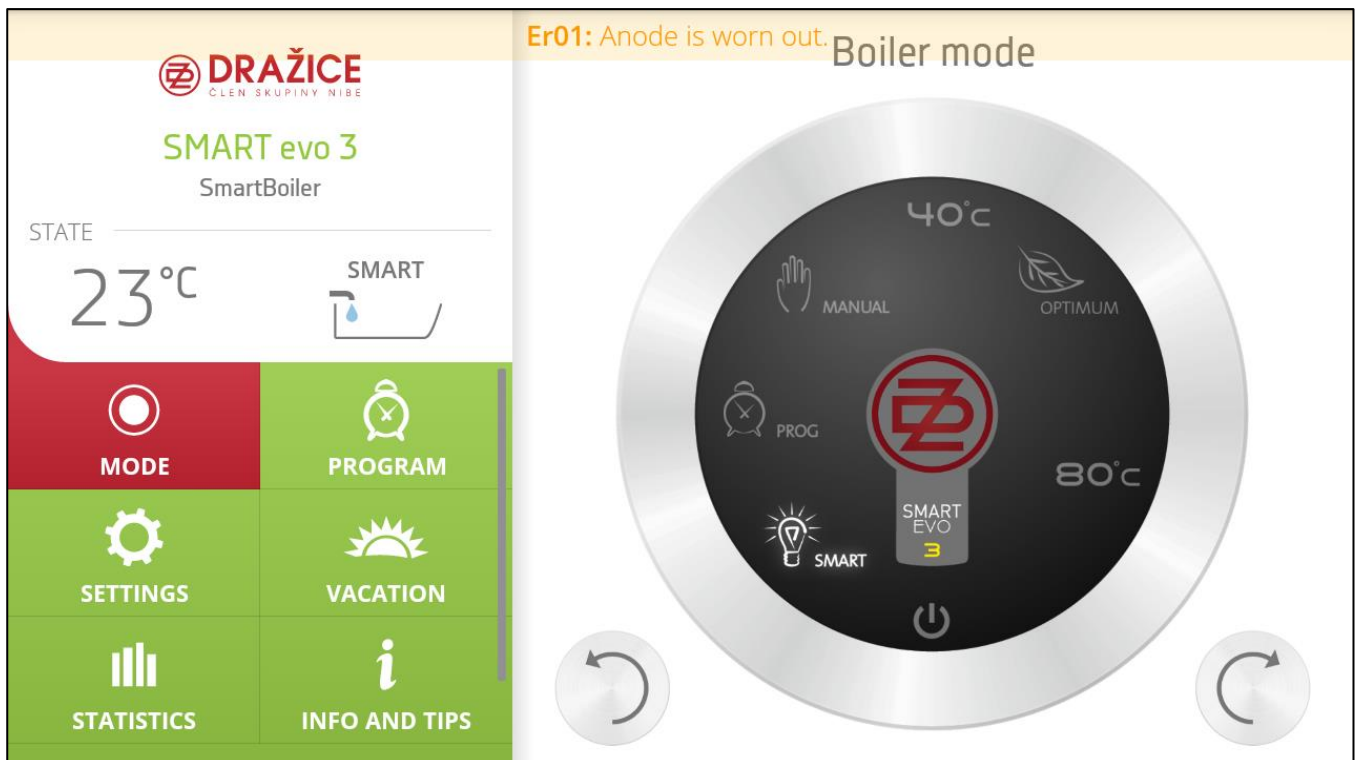

Figure 12: Mode screen in width display

#### 4.1.5 PROGRAM SECTION

This section enables setting the mode „Program“ by means of two operating boiler temperatures and their assignment to individual hours in the week. Temperature symbolized with grey wheel represents the reduction and temperature symbolized with orange, red wheel represents higher heating. Text „Now“ represents the actual set temperature.

The assignment of required values to the hours in a week is performed by means of the field with round buttons in two steps. After the first pressing of the specified round button, the initial option location is marked, then it is necessary to indicate the selection surface by clicking the next round button, it enables to set the joint hours by means of two clicks for the selected operating temperature e.g. for all days in the week, etc.

If the user moves to section Program and the actual boiler mode is not set to mode „Program“, the notification is issued (see Figure 14: Notification of the program mode). Setting in the program section is indicated only if it the operating boiler mode includes the set mode „Program“.

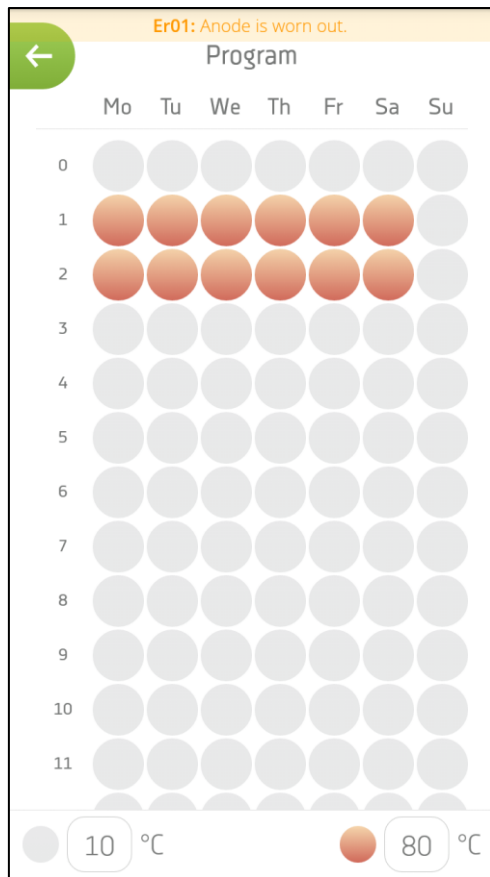

Figure 13: Setting the program mode

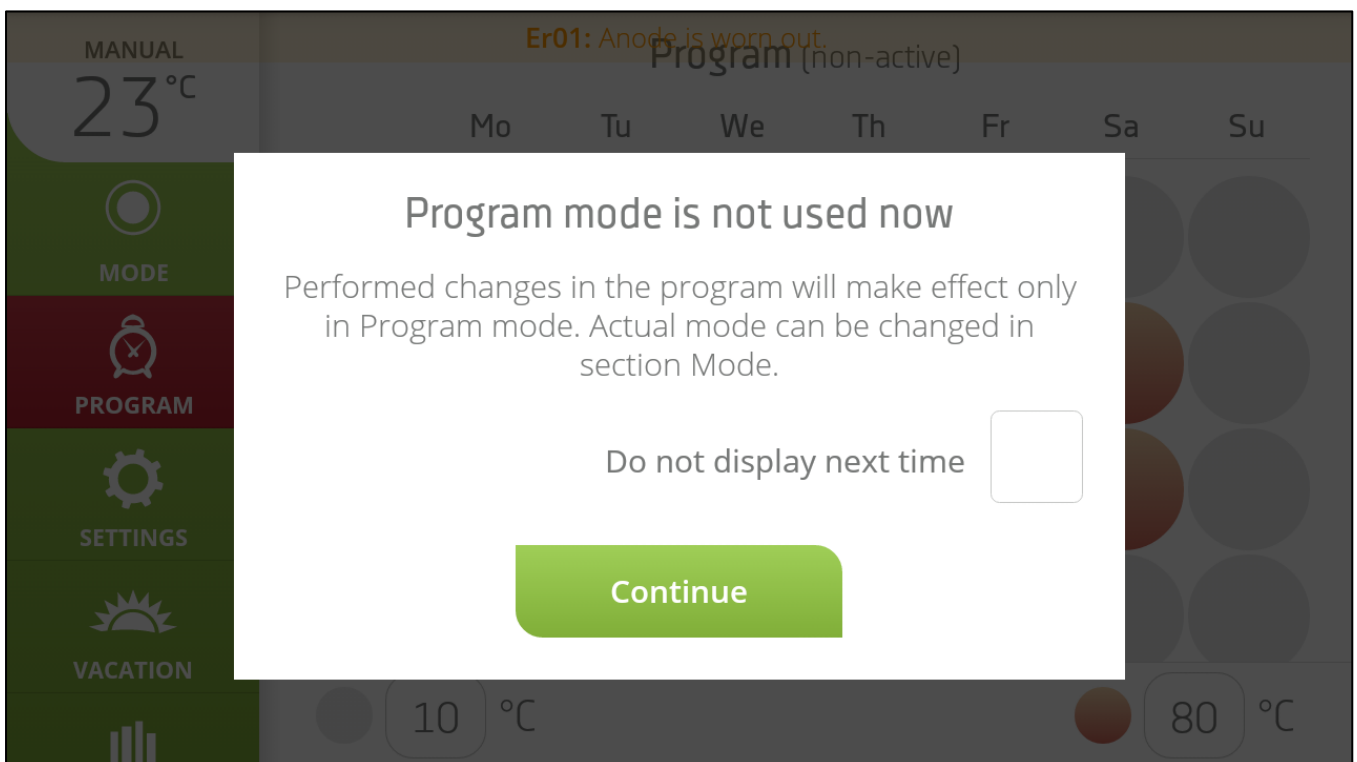

Figure 14: Notification of the program mode

#### 4.1.6 VACATION SECTION

Section for setting the period when the heater is in mode „ANTI-FREEZE“. The displayed calendar in this case is used only for the vacation deadline visualization, and it has no further function. Information on the ongoing vacation is visibly specified in the status information in the main signpost during the height mode, or on the left panel in the width mode. Vacation in progress can be cancelled by means of the respective button.

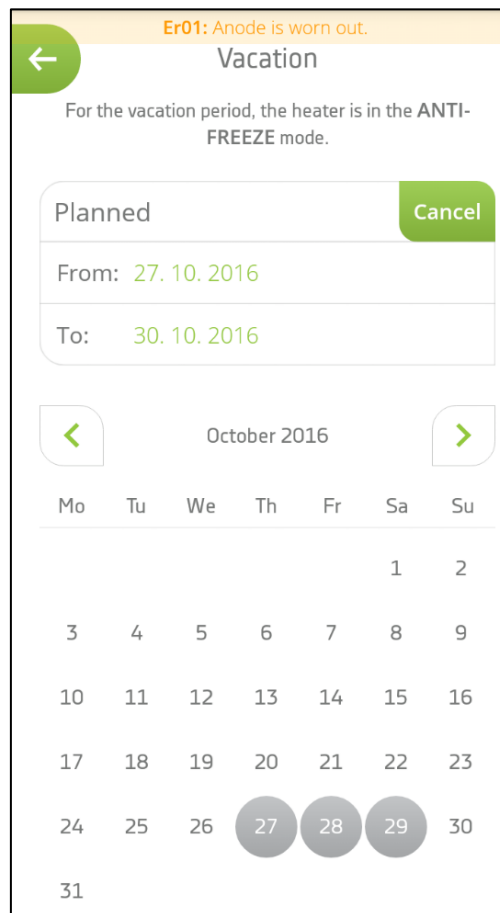

Figure 15: Vacation screen

#### 4.1.7 STATISTICS SECTION

Power consumption visualization for the heater operation by means of annual graph for the last year and the last week together with total consumption. Total consumption is measured from the day of the first boiler start or after pressing button 'Reset' from the specified moment.

Statistics screen (see Figure 16: Statistics screen) provides simple graphs with the review of the power consumption by the boiler in individual months and for the last seven days. It also includes data on total boiler consumption from the first day of commissioning or from the last reset measuring. Measuring the resetting can be reset by clicking on the respective button. The measured values for the last month or day are displayed in blue in kilowatt (kWh) units, grey displayed data represent the measured values for the actual month and day.

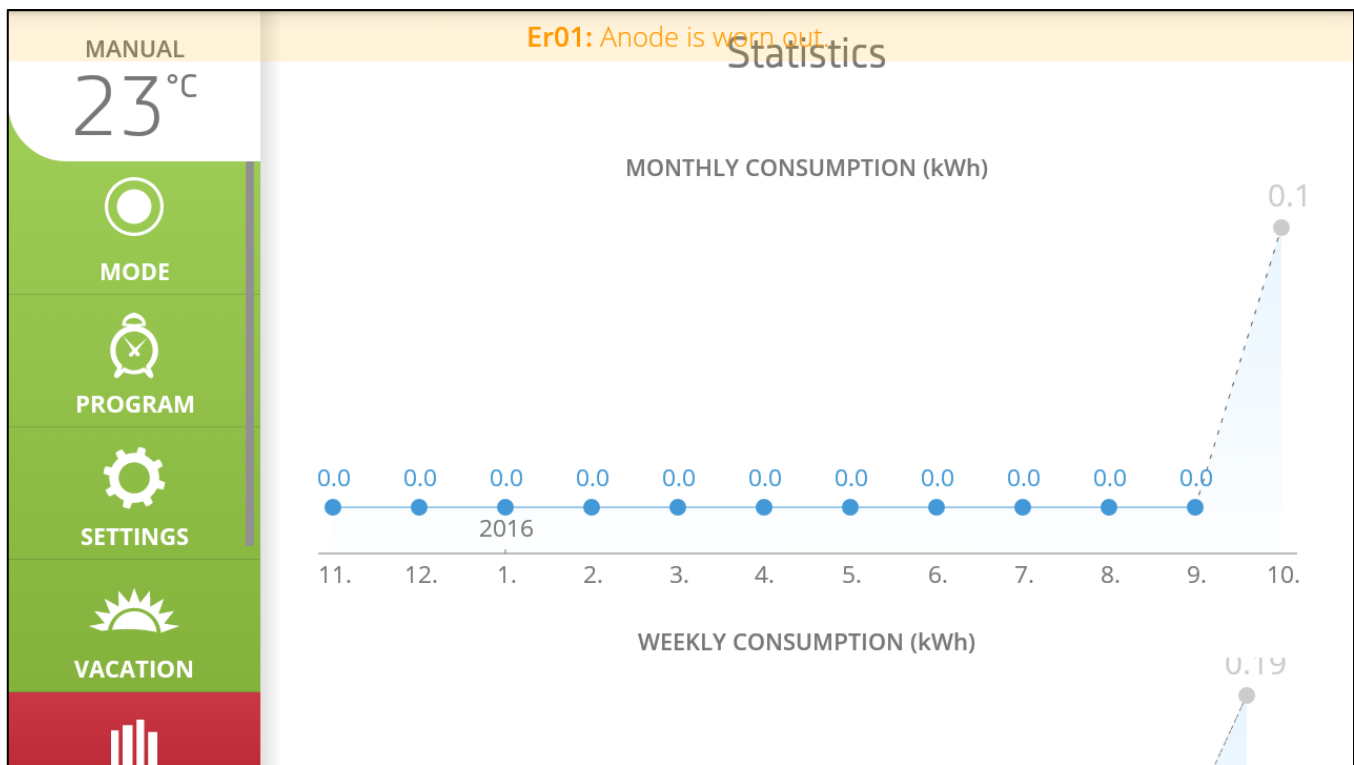
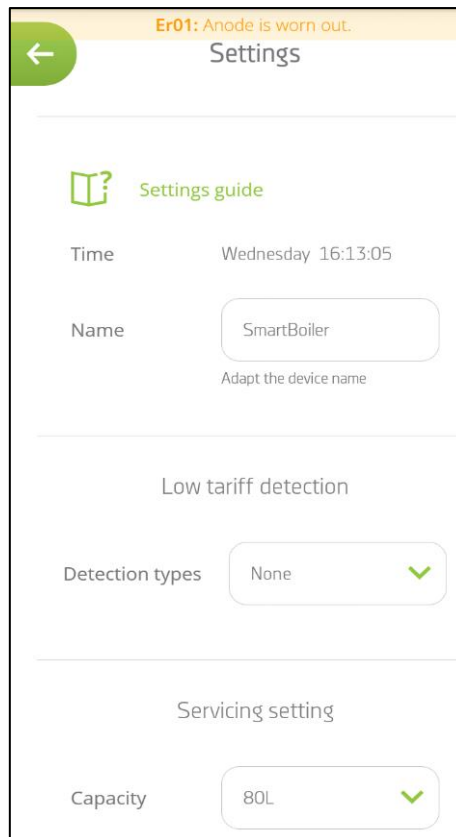

Figure 16: Statistics screen

#### 4.1.8 SECTION SETTINGS

The SETTING section enables to additionally synchronize boiler time, unless it was completed after starting the application. The name and the capacity of the heater can be changed, too (defined from the production by the production plate), or HDO detection type selected. HDO can be selected with automatic detection, or intervals in individual days set (every five minutes). At this point, the HDO function can be completely turned off. In the Setting section, you can further retrospectively open the main fast-selection signpost, as advised in chapter 4.1.3 Signpost on first startup. In the bottom part you can further check whether the newest software has been installed; otherwise the application offers the installation automatically. In this installation it is recommended to leave only Bluetooth active on the mobile device, and switch off any other radio transmissions, such as Wi-Fi and data connection. Once the update is completed, the heater restarts and the application displays a window with a message that the newest firmware has been installed. It is possible to set the name of the connected boiler which is suitable in situation the user owns more SMART heaters and it is necessary to differentiate them simply. If error occurs, there is an option of returning to the factory state. The option "Disconnection" at the end of the section enables to disconnect the paired heater and connect different heater.



**Figure 17: Setting screen**

The application is designed for the servicing technicians and contains additional servicing settings which enable to configure the boiler volume or HDO parameters.

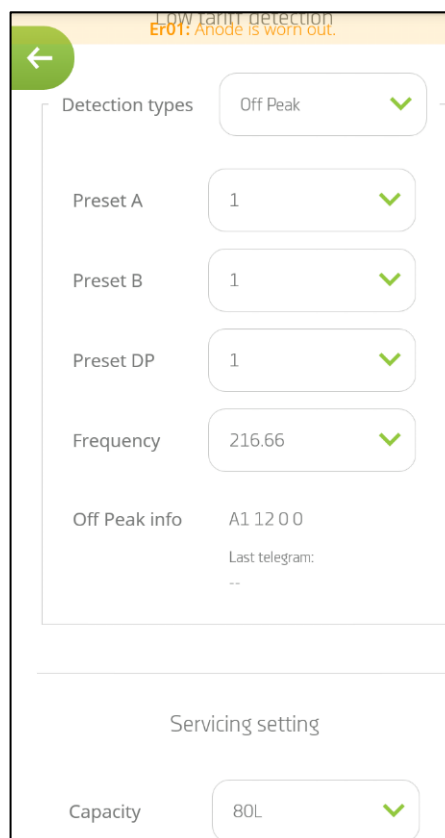

**Figure 18: Setting screen (HDO)**

#### 4.1.9 INFO AND TIPS

The section contains information on SMART technology with the definition of the main functions and smart boiler modes.

#### 4.1.10 SYNCHRONIZING TIME

After the application start, the actual thermostat time is automatically checked. If the time differs from the time in the mobile device, the user can press the button „Synchronize“ to set time in thermostat according to the time in mobile application.

#### 4.1.11 SAVING THE COMPLETED SETTING

After completing the setting e.g. after setting the actual mode, vacation term, or program, after short time the required temperature is sent to the boiler, the sending is signaled by illustrated icon in the right top corner, which disappears after the setting.

## 5 IMPORTANT NOTICES

### 5.1 INSTALLATION REGULATIONS

- **Without a confirmation issued by an authorized company about performed electrical and plumbing fixture the warranty certificate shall be void.**
- **The electrical connection of the heater must not be controlled by the HDO signal.**
- Check and exchange the Mg anode regularly.
- You have to apply for approval of a local power supplier to connect the heater.
- **No stop valves can be put between the heater and the safety valve.**
- If the overpressure in the water main exceeds 0.48 MPa, a pressure control valve must be mounted before the safety valve.
- All hot water outputs must have a combination faucet.
- Before filling the heater with water for the first time, it is recommended to fasten the flange connection nuts of the tank. Screws has to be tightened by cross, tightening moment 15Nm.
- It is not allowed to handle the thermostat, aside from temperature resetting with a control button.
- All electric installation handling, adjustment and replacement of the regulation elements shall only be performed by an authorized service company.
- **The thermal fuse must not be turned off!** In case of thermostat defect, the thermal fuse interrupts electric power input to the heating element if the water temperature in the heater exceeds 90 °C.
- If you don't use the heater (hot water tank) for longer than 24 hours, or if the facility with heater is unattended, close the cold water inlet to the heater.
- The heater (hot water tank) shall be used exclusively in accordance with the conditions specified on the performance plate and in the instructions for electric wiring.



**Both the electric and water installation must follow and meet the requirements and regulations relevant in the country of use!**



**The device has to be mounted at a convenient place, it means that the device must be easily available for potential necessary maintenance, repair or replacement, as the case may be.**



## 5.2 TRANSPORT & STORAGE INSTRUCTIONS

The device shall be transported and stored in dry place and protected from weather effects with temperature range from -15 to +50 °C. During loading and unloading the instructions stated on the packaging shall be observed.

## 5.3 DISPOSAL OF PACKAGING MATERIAL AND NON-FUNCTIONING PRODUCT

A service fee for providing return and recovery of packaging material has been paid for the packaging in which the water heater was delivered. The service fee was paid pursuant to Act No 477/2001 Coll., as amended, at EKO-KOM a.s. The client number of the company is F06020274. Take the water boiler packages to a waste disposal place determined by the town. When the operation terminates, disassemble and transport the discarded and unserviceable heater to a waste recycling center (collecting yard), or contact the manufacturer.



15-1-2024